

C9, C10, C11, C12, C13, C14, C15, C16, C17, C18, C31, C42, C43, C44, C45, C46, C47, C48, C49, C50, C51, C52, C53, C56, C57, C58, C59, C62, C63: 100nF
 U1, U2, U3, U4, U5, U9, U10, U11, U12, U14: OPA2134
 U6, U7, U8: DG412
 D3, D4, D5, D8, D9: 1N914

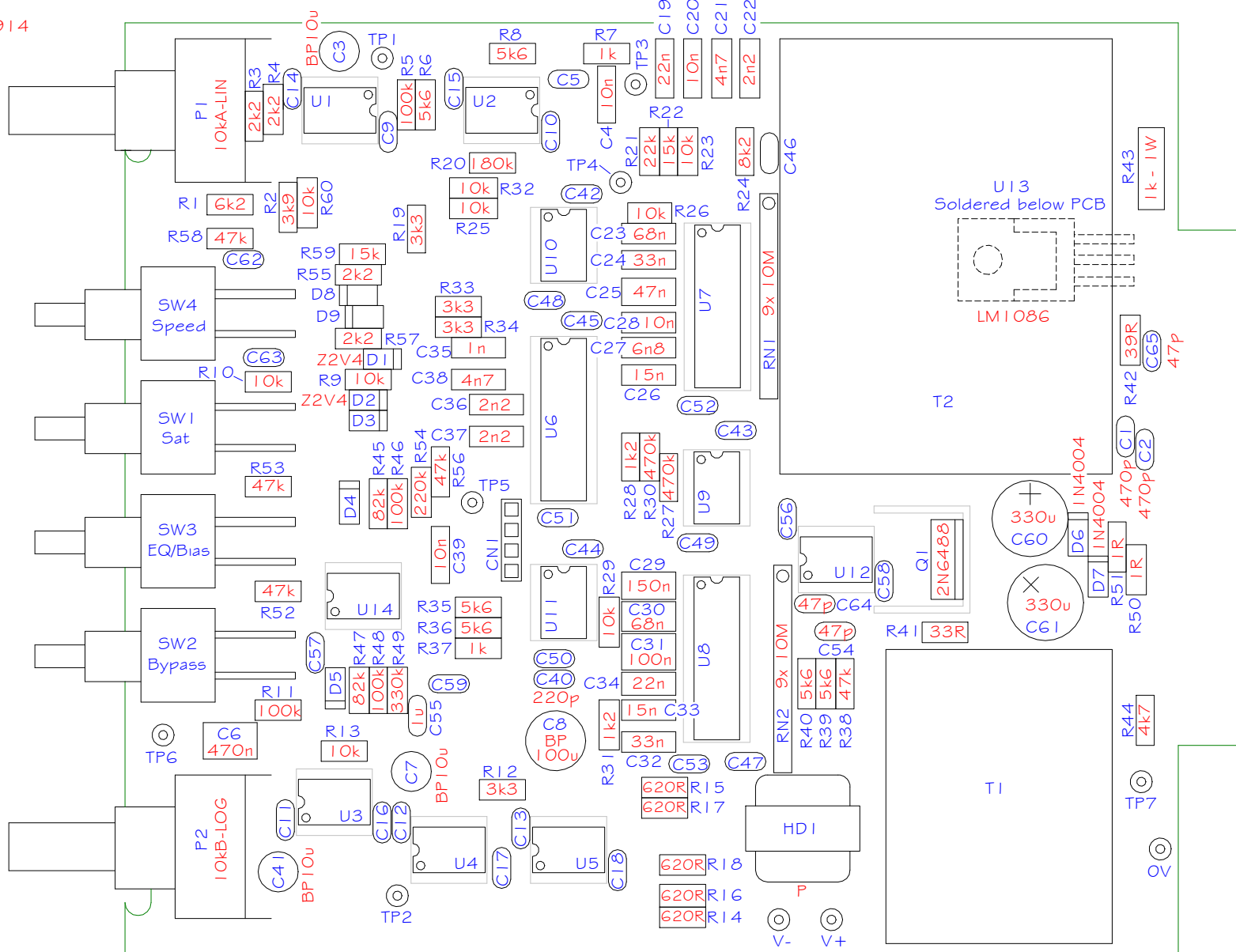

SOUND SKULPTOR	Title	TS500 Component Layout	Sch Rev	1.4
	www.soundskulptor.com Copyright ©2016 to today Soundskulptor		PCB Rev	1.5
			Last modified	16/04/21

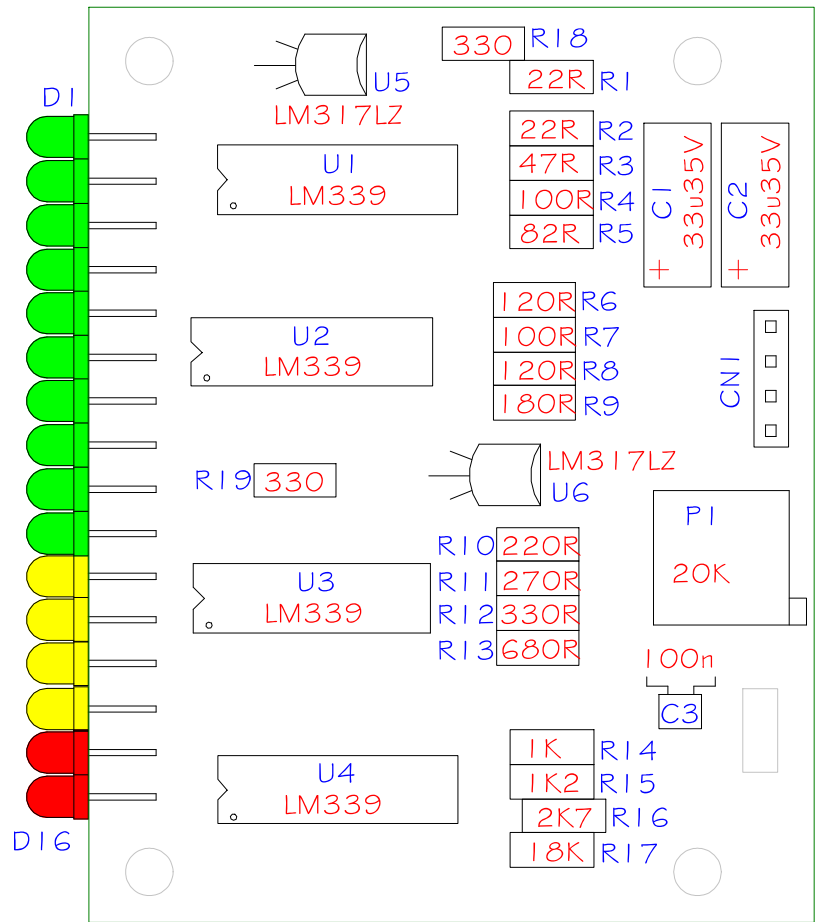

SOUND SKULPTOR	Title TS500 meter	Sch Rev 1.1
	www.soundskulptor.com Copyright ©2013-today Soundskulptor	PCB Rev 1.5
		Last modified 16/05/19